

*Mobile Link™ Cellular 4G LTE
Remote Monitoring
Installation and User Manual*

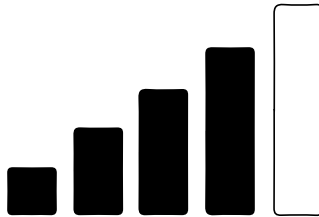

Mobile Link Customer Support
<http://support.mobilelinkgen.com>
US: 1-855-436-8439
Canada: 1-844-843-9436

Para español , visita: <http://www.generac.com/service-support/product-support-lookup>

Pour le français, visiter : <http://www.generac.com/service-support/product-support-lookup>

SAVE THIS MANUAL FOR FUTURE REFERENCE

Generator Model:	
Generator Serial Number:	
Mobile Link Serial Number:	
Mobile Link IMEI:	
ICCID Number:	
Date Purchased:	

Record the information found on the unit data label on this page. Always supply the complete model and serial numbers of the unit when contacting an Independent Authorized Service Dealer (IASD) about parts and service. For troubleshooting connectivity problems, the Mobile Link IMEI and ICCID numbers should also be provided. They can be found on the label affixed to the unit.

Operation and Maintenance: Correct maintenance and care of the unit ensures a minimum number of problems and keeps operating expenses at a minimum. It is the operator's responsibility to perform all safety inspections, verify all maintenance for safe operation is performed promptly, and to have the equipment inspected periodically by an IASD. Normal maintenance, service, and replacement of parts are the responsibility of the owner/operator and are not considered defects in materials or workmanship within the terms of the warranty. Individual operating habits and usage may contribute to the need for additional maintenance or service. When the unit requires servicing or repairs, the manufacturer recommends contacting an IASD for assistance. Authorized service technicians are factory-trained and are capable of handling all service needs.

NOTE: The International Mobile Equipment Identity (IMEI) number is located on the bottom of the Mobile Link Cellular 4G LTE device.

Table of Contents

Section 1: Safety

Introduction	4
Antenna Statement	4
Read This Manual Thoroughly	4
Safety Rules	4
General Safety	5
General Safety Hazards	5
Electrical Hazards	5
Explosion Hazards	6

Section 2: General Information and Setup

Introduction	7
Description	7
Website Information Screens	7
Mobile Link Cellular Information Screen	7

Section 3: Installation, Operation, and Troubleshooting

Mobile Link Kit Numbers	9
Installation	9
Disable Wi-Fi	9
Main Circuit Breaker Locations	10
Prepare Generator (New Installations)	10
Prepare Generator (Equipped with Existing Mobile Link Unit)	11
Connect New Mobile Link Unit	11
Complete Unit Installation (New and Retrofit)	13
Troubleshooting	14

Section 4: Registration

Section 5: Mobile Link Cellular App

 **WARNING**

CANCER AND REPRODUCTIVE HARM

www.P65Warnings.ca.gov

(000393a)

Section 1: Safety

Introduction

Thank you for purchasing this home standby generator product accessory.

NOTE: This device complies with Part 15 of the FCC Rules (and with Industry Canada license-exempt RSS standard(s)). Operation is subject to the following two conditions:

- this device may not cause harmful interference, and
- this device must accept any interference received, including interference that may cause undesired operation.

NOTE: Changes or modifications made to this equipment not expressly approved by the manufacturer may void the FCC authorization to operate this equipment.

Antenna Statement

Under Industry Canada regulations, this radio transmitter may only operate using an antenna of a type and maximum (or lesser) gain approved for the transmitter by Industry Canada. To reduce potential radio interference to other users, the antenna type and its gain should be so chosen that the equivalent isotropically radiated power (EIRP) is not more than that necessary for successful communication.

The information in this manual is accurate based on products produced at the time of publication. The manufacturer reserves the right to make technical updates, corrections, and product revisions at any time without notice.

NOTE: Wi-Fi[®] is a registered trademark of Wi-Fi Alliance[®].

Read This Manual Thoroughly



WARNING

Consult Manual. Read and understand manual completely before using product. Failure to completely understand manual and product could result in death or serious injury. (000100a)

If any section of this manual is not understood, contact Mobile Link customer support at 1-855-436-8439 (CAN 844-843-9436) or visit www.mobilelinkgen.com for starting, operating, and servicing procedures. The owner is responsible for correct maintenance and safe use of the unit.

SAVE THESE INSTRUCTIONS for future reference. This manual contains important instructions that must be followed during

placement, operation, and maintenance of the unit and its components. Always supply this manual to any individual that will use this unit.

Safety Rules

The manufacturer cannot anticipate every possible circumstance that might involve a hazard. The alerts in this manual, and on tags and decals affixed to the unit, are not all inclusive. If using a procedure, work method, or operating technique that the manufacturer does not specifically recommend, verify that it is safe for others and does not render the equipment unsafe.

Throughout this publication, and on tags and decals affixed to the unit, DANGER, WARNING, CAUTION, and NOTE blocks are used to alert personnel to special instructions about a particular operation that may be hazardous if performed incorrectly or carelessly. Observe them carefully. Alert definitions are as follows:

DANGER

Indicates a hazardous situation which, if not avoided, will result in death or serious injury.

(000001)

WARNING

Indicates a hazardous situation which, if not avoided, could result in death or serious injury.

(000002)

CAUTION

Indicates a hazardous situation which, if not avoided, could result in minor or moderate injury.

(000003)

NOTE: Notes contain additional information important to a procedure and will be found within the regular text of this manual.

These safety alerts cannot eliminate the hazards that they indicate. Common sense and strict compliance with the special instructions while performing the action or service are essential to preventing accidents.

General Safety



⚠️ WARNING

Consult Manual. Read and understand manual completely before using product. Failure to completely understand manual and product could result in death or serious injury. (000100a)

The manufacturer cannot anticipate every possible circumstance that might involve a hazard. The safety messages in this manual and on tags and decals affixed to the unit are, therefore, not all-inclusive. If using a procedure, work method or operating technique the manufacturer does not specifically recommend, verify it is safe for personnel. Also make sure the procedure, work method or operating technique utilized does not render the generator unsafe.

General Safety Hazards



⚠️ DANGER

Electrocution. High voltage is present at transfer switch and terminals. Contact with live terminals will result in death or serious injury. (000129)

⚠️ WARNING

Accidental Start-up. Disconnect the negative battery cable, then the positive battery cable when working on unit. Failure to do so could result in death or serious injury. (000130)

⚠️ WARNING

Risk of injury. Do not operate or service this machine if not fully alert. Fatigue can impair the ability to service this equipment and could result in death or serious injury. (000215)

⚠️ WARNING

Injury and equipment damage. Do not use generator as a step. Doing so could result in falling, damaged parts, unsafe equipment operation, and could result in death or serious injury. (000216)



⚠️ CAUTION

Equipment damage. Do not make battery connections in reverse. Doing so will result in equipment damage. (000167a)

- For safety reasons, the manufacturer requires that this equipment be initially installed by an IASD or other competent, qualified electrician or installation technician who is familiar with applicable codes, standards, and regulations. The operator also must comply with all such codes, standards, and regulations. Repair generally requires simple replacement of the assem-

bled with a new unit, which can usually be performed by the generator owner.

- Before performing any work near the generator, remove the control panel fuse and disconnect the black negative (-) battery cable to prevent accidental startup. When disconnecting battery cables, always remove the negative (-) battery cable first, then remove the red positive (+) battery cable. When connecting battery cables, connect positive (+) battery cable first, and then negative (-) battery cable.

Electrical Hazards



⚠️ DANGER

Electrocution. Contact with bare wires, terminals, and connections while generator is running will result in death or serious injury. (000144)



⚠️ DANGER

Electrocution. Do not wear jewelry while working on this equipment. Doing so will result in death or serious injury. (000188)



⚠️ DANGER

Electrocution. Water contact with a power source, if not avoided, will result in death or serious injury. (000104)

⚠️ DANGER

Automatic start-up. Disconnect utility power and render unit inoperable before working on unit. Failure to do so will result in death or serious injury. (000191)



⚠️ DANGER

Electrocution. In the event of electrical accident, immediately shut power OFF. Use non-conductive implements to free victim from live conductor. Apply first aid and get medical help. Failure to do so will result in death or serious injury. (000145)



⚠️ WARNING

Moving Parts. Do not wear jewelry when starting or operating this product. Wearing jewelry while starting or operating this product could result in death or serious injury. (000115)



⚠️ WARNING

Electrocution. Potentially lethal voltages are generated by this equipment. Render the equipment safe before attempting repairs or maintenance. Failure to do so could result in death or serious injury. (000187)

- This product is intended to be installed in conjunction with an automatic standby generator. The generator may crank and start

at any time when utility is lost. When this occurs, load circuits are transferred to the STANDBY (generator) power source. Before working on this generator (for inspection, service, or maintenance), to prevent possible injury, always set the generator to the OFF mode and remove the 7.5A fuse from the generator control panel.

- Verify all appropriate covers, guards and barriers are in place, secured, and/or locked before operating the generator. If work must be done around an operating unit, stand on an insulated, dry surface to reduce potential shock hazard.

Explosion Hazards



▲ DANGER

Explosion and fire. Fuel and vapors are extremely flammable and explosive. No leakage of fuel is permitted. Keep fire and spark away. Failure to do so will result in death or serious injury. (000192)



▲ DANGER

Explosion and Fire. Fuel and vapors are extremely flammable and explosive. Store fuel in a well ventilated area. Keep fire and spark away. Failure to do so will result in death or serious injury. (000143)



▲ WARNING

Explosion and fire risk. Do not smoke near unit. Keep fire and spark away. Failure to do so could result in death, serious injury, or property or equipment damage. (000282)

- Verify no combustible materials are left in the generator compartment or on or near the generator as FIRE or EXPLOSION may result. Keep the area surrounding the generator clean and free from debris.
- Gaseous fluids, such as natural gas (NG) and liquid propane (LP) gas, are extremely EXPLOSIVE. Install fuel supply system according to applicable fuel-gas codes. Before placing the home standby electric system into service, fuel system lines must be correctly purged and leak tested according to applicable code. Inspect the fuel system periodically for leaks. No leakage can be permitted.

Section 2: General Information and Setup

Introduction

This section of the manual describes the features and controls of the Mobile Link cellular remote monitoring system. Every effort was made to ensure that the information and instructions in this manual were both accurate and current at the time the manual was written. However, the manufacturer reserves the right to change, alter, or otherwise improve this product or manual at any time without prior notice.

Description

The Mobile Link cellular remote monitoring system allows generator status and operating information to be monitored from anywhere the owner has access to a cellular network. Verizon is the cellular network provider. The Mobile Link cellular unit is mounted on the outside of the generator and communicates with the generator's controller via a serial port.

After the generator is registered with www.MobileLinkGen.com, owners can log onto the website to check on the current status of the generator at any time. Registering the generator also enables the system to notify the owner of any change in operating status.

The owner will be contacted by e-mail, push notifications, or text messages if alarms or warnings occur. The delivery method and frequency of these alerts can be adjusted on the website.

NOTE: E-mail and text notifications can be managed through the website. Push notifications are also available and can be managed through the use of the Mobile Link App. See [Mobile Link Cellular App](#) for downloading instructions.

Website Information Screens

The Mobile Link cellular unit sends messages to alert the owner when scheduled maintenance is required on the generator. The generator's total run hours can be viewed, and a log of completed maintenance can be generated.

Generator exercise time can also be checked and altered, if desired, through visiting www.MobileLinkGen.com.

Wire Harness Part Numbers	
10000038669	Mobile Link 4G LTE to Evolution 2.0 Controller
10000030045	Mobile Link 4G LTE to Pre-Evolution 2.0 Controller

Mobile Link Cellular Information Screen

See [Figure 2-1](#) and [Figure 2-2](#). Logging into the Mobile Link App launches an Information Screen. The Information Screen displays an overview of each generator being monitored by Mobile Link. A picture of the generator appears on screen against a color-coded background. Background color indicates at-a-glance operating status:

- **Green:** Generator is ready to operate.
- **Blue:** Generator is currently operating.
- **Yellow:** Generator requires maintenance, but is otherwise ready to operate.
- **Red:** Generator has a functional problem and requires immediate service, or generator is set to OFF.
- **Gray:** Generator not connected to Mobile Link.

An instrument cluster (A) displays total generator running time, time on backup power, time on exercise, battery voltage, and fuel level (diesel units only).

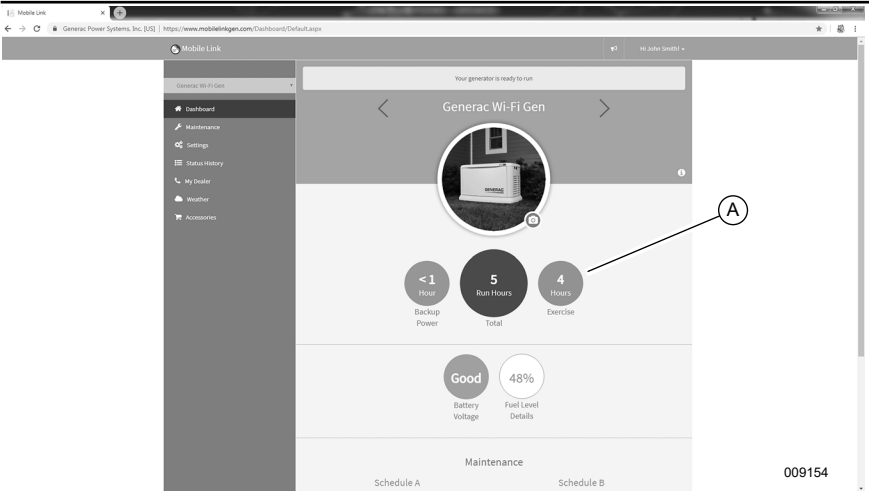

Figure 2-1. Mobile Link Cellular Information Screen

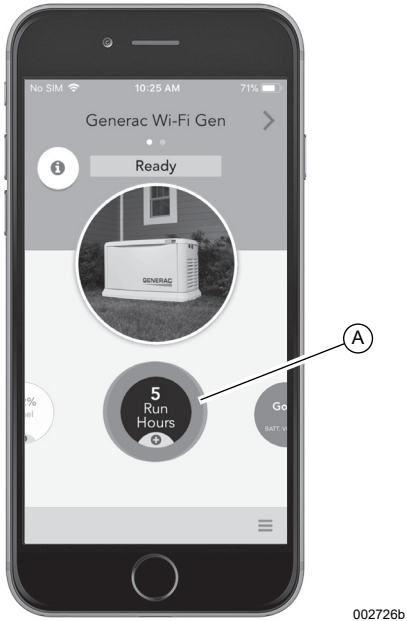

Figure 2-2. Mobile Link App Interface

Section 3: Installation, Operation, and Troubleshooting

Mobile Link Kit Numbers

There are two distinct kits for Mobile Link cellular units. One kit is designed for installation with a new generator. The other kit is designed for retrofit on existing generators which are equipped with an older Mobile Link cellular unit.

Verify the kit number is correct for the installation before proceeding:

Part No.	Description
G0071690	New installations Mobile Link Cellular 4G LTE Device
G0072020	Retrofit Mobile Link Cellular 4G LTE Device

Installation

NOTE: Verify correct generator operation and performance before adding a Mobile Link Cellular unit during a new generator installation.

Disable Wi-Fi

Generators with Evolution 2.0 controllers are equipped with a Wi-Fi module on the rear panel. Wi-Fi functionality (if enabled) must be disabled before installing a Mobile Link cellular unit. Proceed as follows to disable Wi-Fi:

1. See [Figure 3-1](#). With the generator operating, enter Wi-Fi menu by selecting "WIFI" on the controller display.

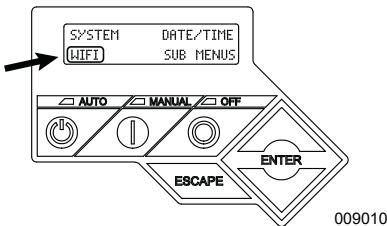

Figure 3-1. Enter Wi-Fi Menu

NOTE: "WIFI" may not appear on the controller display. In either of the following cases, proceed to [Main Circuit Breaker Locations](#):

- Blank space in this area indicates generator is not equipped with Wi-Fi.

- "WiFi Setup?" indicates generator is equipped with Wi-Fi, but functionality is already disabled or has not been set up.
2. See [Figure 3-2](#). Use arrow keys to toggle between "Yes" and "No." Select "No" and press ENTER.

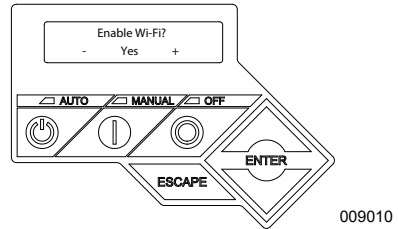

Figure 3-2. Enable/Disable Wi-Fi

3. Press ESCAPE to return to default controller display.

NOTE: To enable Wi-Fi:

1. Re-enter the Wi-Fi menu.
2. Toggle "Enable Wi-Fi" option to "Yes."
3. Press ENTER.
4. Press ESCAPE to return to the default controller display.

Main Circuit Breaker Locations

See [Figure 3-3](#). Depending on the generator model, the main circuit breaker is located either in an external breaker box (A), or internally near the controller (B).

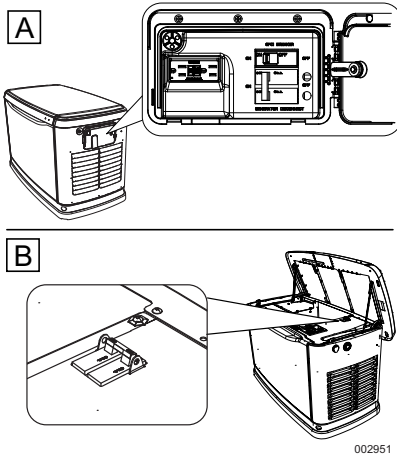

Figure 3-3. Main Circuit Breaker Locations

Prepare Generator (New Installations)



▲ DANGER

Electrocution. Do not wear jewelry while working on this equipment. Doing so will result in death or serious injury.

(000188)

1. Unlock both locks, open generator lid, and remove front panel.
2. See [Figure 3-4](#). If generator is equipped with an internal breaker near the controller, remove end panel from right side. Otherwise, proceed to Step 3.

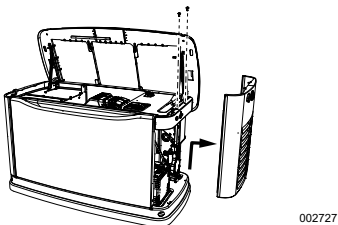

Figure 3-4. Removing End Panel (Internal Breaker)

3. Turn generator OFF. Remove generator panel fuse.

NOTE: There are different controller configurations for various model years.

4. Turn main utility disconnect breaker in home's electrical panel to OFF or OPEN.
5. Using an appropriate fuse puller, remove T1 fuse from transfer switch.
6. Disconnect negative (-) battery cable, then positive (+) battery cable.
7. If generator is equipped with an external breaker box, remove controller sheet metal cover and fasteners.
8. See [Figure 3-5](#). 2013 and later models have a pre-positioned dimple on the end panel. The dimple marks the center of the mounting hole to be drilled.

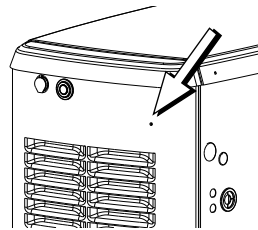
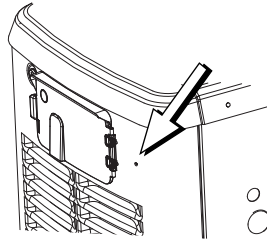

Figure 3-5. Pre-Positioned Dimple

9. Inspect area behind external breaker box to verify all wires are moved out of the way to prevent damage during drilling.

NOTE: Models equipped with an internal breaker mounted near the controller will already have the end panel removed at this point. Carefully place the end panel face up on a clean, smooth, flat surface to avoid damaging the paint.

10. Drill a 1-1/8 in (29 mm) diameter hole with the dimple as the center point.
11. Proceed to [Connect New Mobile Link Unit](#).

Prepare Generator (Equipped with Existing Mobile Link Unit)



▲ DANGER

Electrocution. Do not wear jewelry while working on this equipment. Doing so will result in death or serious injury.

(000188)

1. Unlock both locks, open generator lid, and remove front panel.
2. See [Figure 3-6](#). If generator is equipped with an internal breaker near the controller, remove end panel from right side. Otherwise, proceed to Step 3.

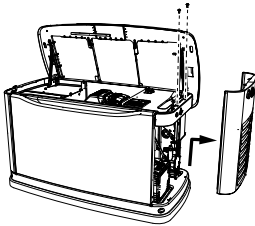

002727

Figure 3-6. Removing End Panel (Internal Breaker)

3. Turn generator OFF. Remove generator panel fuse.

NOTE: There are different controller configurations for various model years.

4. Set main utility disconnect breaker in home's electrical panel to OFF (OPEN).
5. Using an appropriate fuse puller, remove T1 fuse from transfer switch.
6. Disconnect negative (-) battery cable, then positive (+) battery cable.
7. Disconnect wire harness from Mobile Link cellular unit.

NOTE: Existing wire harness, PVC nipple, and washers will be used to connect new Mobile Link cellular unit, leave remaining harness connections in place. Save gaskets and fittings.

8. Unscrew, remove, and discard old Mobile Link cellular unit. Save plastic fitting.
9. If generator is equipped with an external breaker box, remove controller sheet metal cover and fasteners.

NOTE: Models equipped with an internal breaker mounted near the controller will already have the end panel removed at this point. Carefully place the end panel face up on a clean, smooth, flat surface to avoid damaging the paint.

10. Proceed to [Connect New Mobile Link Unit](#).

Connect New Mobile Link Unit

1. See [Figure 3-7](#). Push six pin connector through supplied plastic fitting (A).

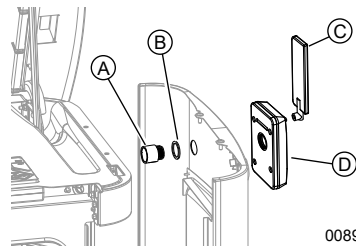
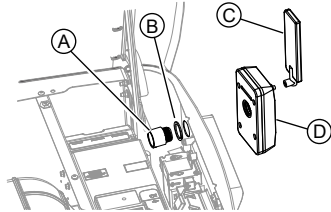

008911

Figure 3-7. Mobile Link Cellular Installation

2. Place green gasket (B) on threaded end of plastic fitting. Push threaded end through controller end panel.
3. Thread antenna (C) into Mobile Link cellular unit (D). Rotate antenna clockwise until secure. Position antenna pointing up.

NOTE: Do not overtighten antenna. Hand tighten only.
4. Insert six pin harness connector from Mobile Link cellular unit into mating connector of wiring harness. Connector will only fit one way. DO NOT force into place.

- See **Figure 3-8**. With connector installed, tighten plastic fitting to secure Mobile Link cellular unit until tight and device is secured to end panel.

- Align antenna vertically.
- Verify Mobile Link logo is at left side.

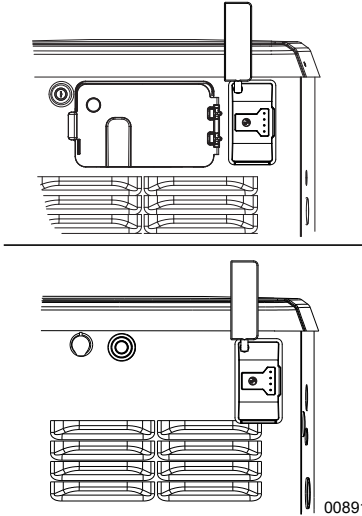

Figure 3-8. Mobile Link Cellular In Place

NOTE: Hold Mobile Link cellular unit firmly and tighten nut during installation to avoid damage to unit wiring harness.

- Route wire harness to back side of controller. Wherever possible, bundle harness with other wire looms to provide additional support.

Continue Installation Process

- If this is a **new** installation, proceed to Step 7.
 - If this is a **retrofit** installation, proceed to **Complete Unit Installation (New and Retrofit)**.
- (New installations only):** Locate accessory port. Accessory port is an eight-pin connector on underside of controller.
 - On models equipped with an external breaker box, lift controller to gain access to accessory plug location.
 - See **Figure 3-9**. On models equipped with an internal breaker mounted near the controller, accessory port is visible from battery compartment when end panel is removed.

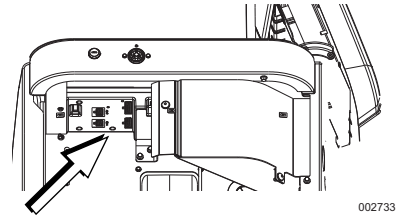

Figure 3-9. Accessory Port (Internal Breaker)

NOTE: If there is a decal labeled “Port 1” or “Accessory Prt 1,” remove decal to locate port.

- Install eight pin connector harness into open socket on controller.

NOTE: The connector will only fit one way. DO NOT force.



CAUTION
Equipment damage. Do not make battery connections in reverse. Doing so will result in equipment damage.

(000167a)

- Connect battery cables. Connect positive battery cable first, then negative battery cable.
- For units equipped with Evolution 1.0 controllers or earlier:** See **Figure 3-10**. Loosen and remove nuts (A) from both positive (+) and negative (-) battery terminal screws on battery cables. Slide harness power wires (B) over battery terminal screws and replace nuts. Tighten securely.

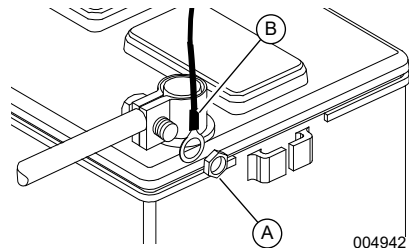
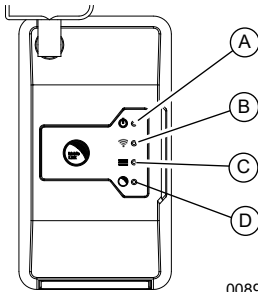

Figure 3-10. Attach Harness Power Wires

NOTE: Harness power wires consist of a black negative (-) wire and a fused red positive (+) wire.

Complete Unit Installation (New and Retrofit)

1. Install end panel, controller, or sheet metal controller cover. Install and tighten retaining fasteners.
2. Verify generator is OFF.
3. Install generator controller fuse.
4. Install T1 fuse into transfer switch using an appropriate fuse puller.
5. Turn main breaker in the home electrical panel to ON. On generator control panel, follow installation wizard and validate correct date, time, etc.
6. Place generator in AUTO.



008913

Figure 3-11. Mobile Link Cellular LEDs

A	<p>Power LED Illuminates if Mobile Link cellular unit is receiving power from generator battery.</p>
B	<p>Cellular Network LED Indicates cellular signal strength.</p> <ul style="list-style-type: none"> • Steady ON indicates strong signal. • Flashing indicates variable or weak signal. • OFF indicates no signal.
C	<p>Connection to Controller LED Indicates status of connection to generator controller.</p> <ul style="list-style-type: none"> • Steady ON indicates generator controller has been identified. • Flashing indicates generator controller is communicating with Mobile Link cellular unit but has not yet been identified. • OFF indicates no connection.
D	<p>Server Connection LED Indicates status of connection to Mobile Link servers.</p> <ul style="list-style-type: none"> • Steady ON indicates verified server connection. • Flashing indicates server connection established but not verified. • OFF indicates no connection.

Troubleshooting

Problem	Cause	Correction
All LEDs off	No power to Mobile Link cellular unit.	Inspect wire harness connections: Evolution 2.0 controller: Mobile Link cellular unit receives power directly from controller. Non-Evolution 2.0 controllers: Mobile Link cellular unit receives power from battery connections.
		Verify harness is correctly connected to battery.
		Reset connector to Mobile Link cellular unit.
Power LED (A) off	No power to Mobile Link cellular unit.	Inspect thermal safety device (fuse, in-line circuit breaker, or thermal coupler) in harness.
		Verify harness is correctly connected to battery.
		Reset connector to Mobile Link cellular unit.
Power LED (A) flickering	Loose electrical connection to Mobile Link cellular unit.	Verify harness is correctly connected to battery.
		Reset connector to Mobile Link cellular unit.
Cellular Network LED (B) flashing or off	Variable or weak connection to cellular network.	Reset connector at generator controller and Mobile Link cellular unit. Verify external antenna is attached tightly to Mobile Link cellular unit.
		Verify external antenna is attached tightly to Mobile Link cellular unit. Replace cable.
		Wait for situation to resolve itself. LED should stop flashing within 10 minutes. If not: <ul style="list-style-type: none"> • Purchase an extender antenna • Contact Customer Support
		NOTE: Cellular coverage may be intermittent. Verify Verizon cellular coverage strength by trying to make a phone call from a Verizon-supported mobile phone near Mobile Link cellular unit, or contact Verizon directly.
Connection to Controller LED (C) off	Mobile Link cellular unit not connected to generator controller.	Reset Mobile Link cellular unit wire harness to generator controller.
		Verify harness connections between Mobile Link cellular unit and generator controller are correct.
	Poor connection to controller.	Wait a few moments. Upon initial startup, Mobile Link will not attempt to communicate with controller for approximately 15 seconds.
		Inspect wire harness and battery connections (if applicable); tighten if necessary.
Connection to Controller LED (C) flashing	Generator controller communicating with Mobile Link cellular unit, but has not yet been identified.	Verify controller is compatible with Mobile Link cellular unit. (Nexus, Evolution 1.0, and Evolution 2.0) Verify all harness connections between Mobile Link cellular unit and generator controller are correct and tight. Light will turn solid when communications are established.
Server Connection LED (D) off	Mobile Link cellular unit not connected to Mobile Link server.	Server may be down. Wait for server response, or contact Mobile Link Customer Support at 1-855-436-8439 (US) or 1-844-843-9436 (CAN).
	Unsupported controller.	Verify controller is Nexus, Evolution 1.0, or Evolution 2.0.
	Mobile Link cellular unit in "Suspended" mode.	Contact Mobile Link Customer Service for assistance: (US) 1-855-436-8439 (CAN) 1-844-843-9436
Server Connection LED (D) flashing	Mobile Link cellular unit connected to Mobile Link servers, but connection is not verified.	Server connection pending. Wait for server response. Connection process may last as long as 10 minutes.

Section 4: Registration

Once the Mobile Link cellular unit has been installed, it should be registered and activated to obtain full benefits of product capabilities.

Gather the following information prior to initiating registration process:

- E-mail address
- **Mobile Link Serial Number** located on label on bottom of unit. A second label on packaging also includes the serial number.
- **Generator serial number** located on label plate, near control panel console.
- Mailing address
- Valid credit card
- **Address of generator location** (if different than mailing address)

Go to www.MobileLinkGen.com to complete the registration process. The welcome screen is shown in [Figure 4-1](#).

1. Click “Sign Up” (A).

2. Enter requested information when prompted, then click “Sign Up.” (B)
3. Enter requested generator enrollment information when prompted, then click “Enroll.”

NOTE: The Mobile Link serial number is located on the bottom of the device and on the device packaging. The generator serial number is located on or in the area of the control panel.

4. Select the types of alerts to receive, how often to receive them, and whether the alerts should be sent as text messages, e-mail messages, or both.
 - Text alert settings can be configured to deliver notifications of any or all changes in generator status.
 - Status changes include such events as faults, warnings, exercise confirmations, or maintenance reminders.

Mobile Link Contact Us Support Sign Up Login

Create a new account

* Required

Not all service levels are available in all countries.

FIRST NAME * LAST NAME *

EMAIL ADDRESS *

PASSWORD *

CONFIRM PASSWORD *

STREET ADDRESS * SUITE / UNIT NUMBER

CITY * COUNTRY *
 USA

ZIP / POSTAL CODE * STATE / PROVINCE
 Alabama

HOME NUMBER * MOBILE NUMBER

End User License Agreement
 I agree to the EULA.

Sign Up

009155

Figure 4-1. Mobile Link Cellular Information Screen

Section 5: Mobile Link Cellular App

Download the Mobile Link Cellular for Generators app:



See [Figure 5-1](#). The Mobile Link Cellular app provides generator data optimized for your mobile device:

- View current generator status and upcoming maintenance needs.
- Remotely set the generator's exercise time.
- Review generator's run and maintenance history.
- Receive generator status change messages, alarms, or warnings through e-mail, push notifications, or text messages.



002726b

Figure 5-1. Mobile Link Cellular for Generators App

Part No. 10000032200 Rev. A 12/12/18
©2018 Generac Power Systems, Inc.
All rights reserved
Specifications are subject to change without notice.
No reproduction allowed in any form without prior
written consent from Generac Power Systems, Inc.

GENERAC®

Generac Power Systems, Inc.
S45 W29290 Hwy. 59
Waukesha, WI 53189
1-888-GENERAC (1-888-436-3722)
www.generac.com